

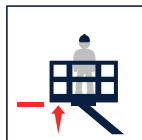

MXE160



15,70 m



13,70 m

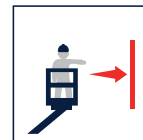

8,50 m (80 kg)
5,50 m (250 kg)



250 kg

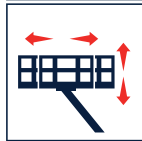

1200x700x1100 mm

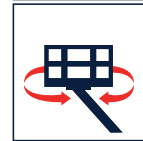

50°+50°



380°



DS
Stabilizzatori a discesa in sagoma
Stabilisateurs dans le gabarit
Straight line stabilizers
Stützen innerhalb der Fahrzeugbreite



3,1 ton

MXE160

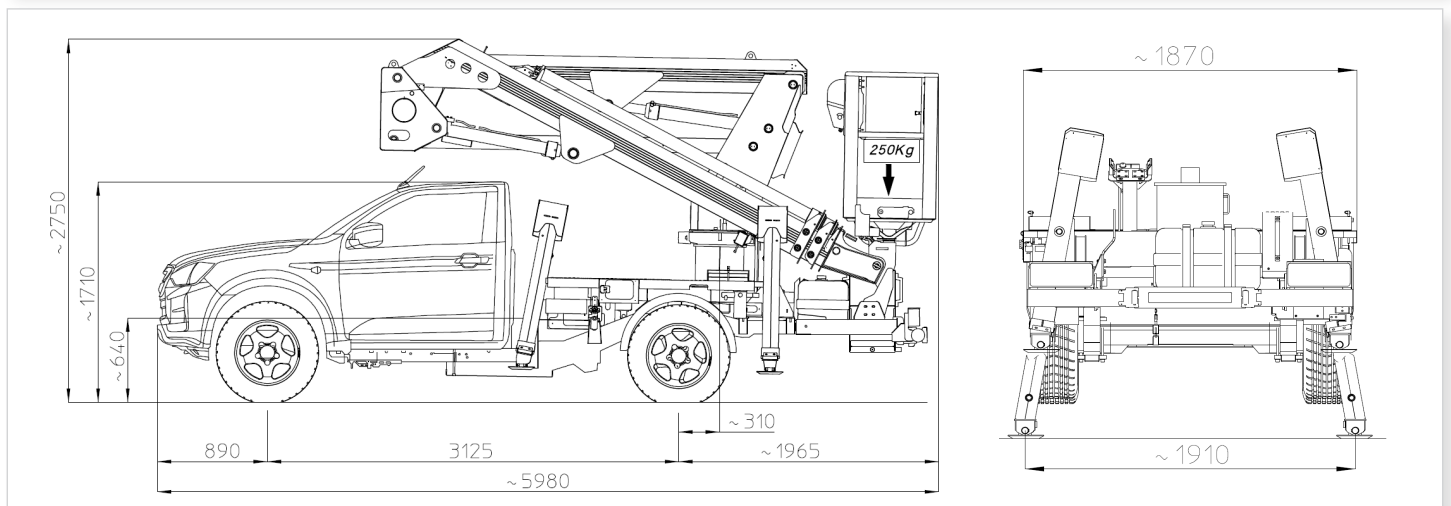
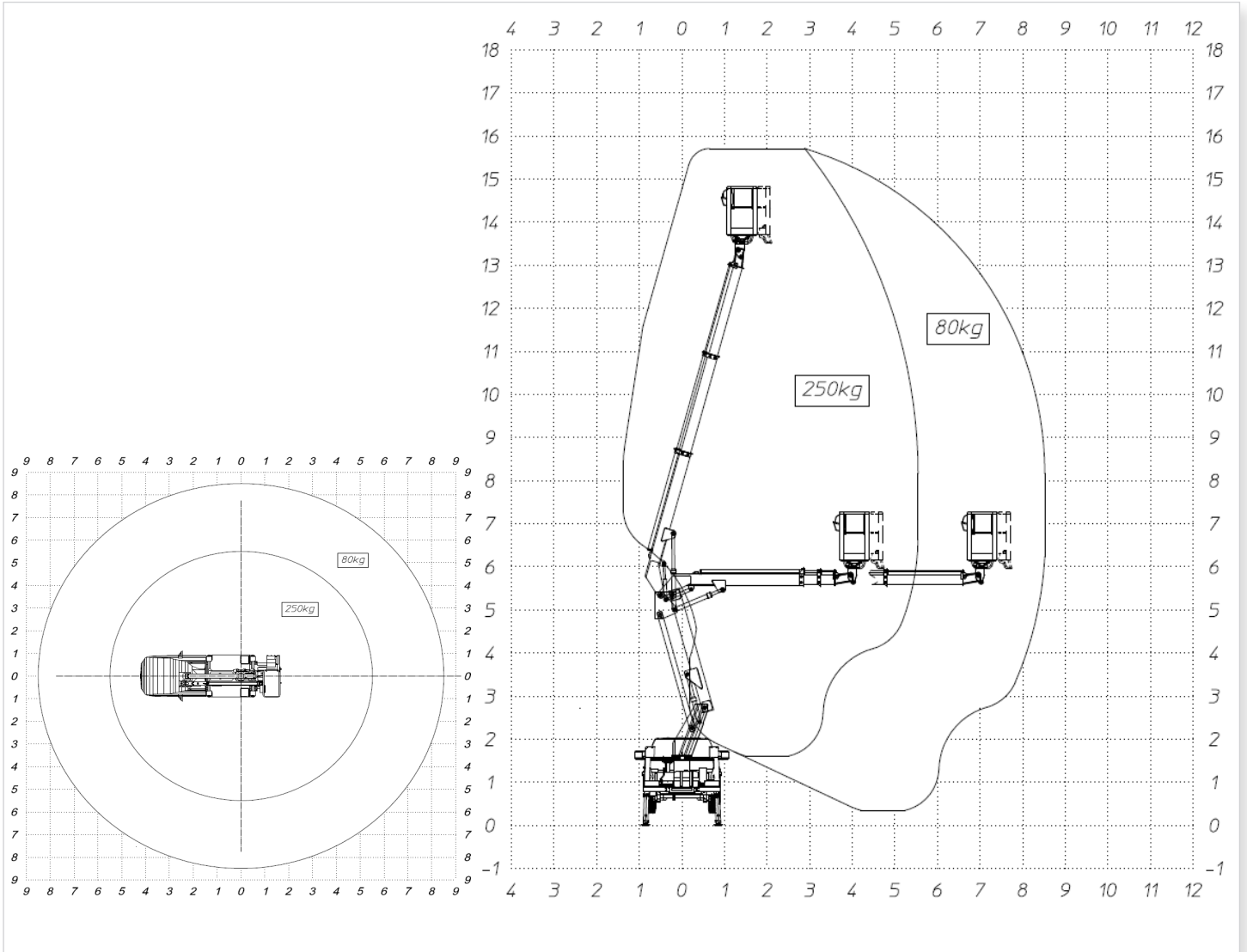

MULTITEL PAGLIERO S.P.A.

Strada Statale, 114
12030 MANTA (CN) - ITALY
Tel. +39 0175 255211
info@pagliero.com

Filiali

Corso Piemonte, 54
10099 S. MAURO T. SE (TO) - ITALY
Tel. +39 011 2236792

Via dell'Offelera, 106
20861 BRUGHERIO (MB) - ITALY
Tel. +39 039 883393/4

MULTITEL INTERNATIONAL SASU

87, rue du Morellon
38070 ST. QUENTIN FALLAVIER - FRANCE
Tel. +33 (0)4 74 94 63 19
accueil@multitelinternational.com

MULTITEL EXPORT SALES GmbH

Carl-Zeiss-Straße, 34
52477 ALSDORF - DEUTSCHLAND
Tel. +49 (0)2404 675 580
exportsales@pagliero.com

MULTITEL UK LTD - operational headquarter

Unit 11 Bilton Court Bilton Way
LU11LX LUTON - UK
Tel. +44 (0)1582 952778
info.uk@pagliero.com

MULTITEL IBERICA SL

C/ Luxemburg, 12
08520 LES FRANQUESES DEL VALLÈS, BARCELONA - ESPAÑA
Tel. +34 93 22 05 633
info.iberica@pagliero.com

www.multitelgroup.com